

NCR K350

RealScan Remote Imager

Configuration Guide



Issue A

Revision Record

Issue	Date	Remarks
A	Aug 2013	First issue

Introduction

The NCR RealScan Remote Imager is a highly flexible and convenient alternative to a handheld scanner.

The Imager module has a long cord which permits the store personnel to mount it in a convenient place for the customer, without requiring precious space on the sales counter. The Imager module is designed to be robust, making it more mobile and enough to be handed to customers in case there is a need for it.

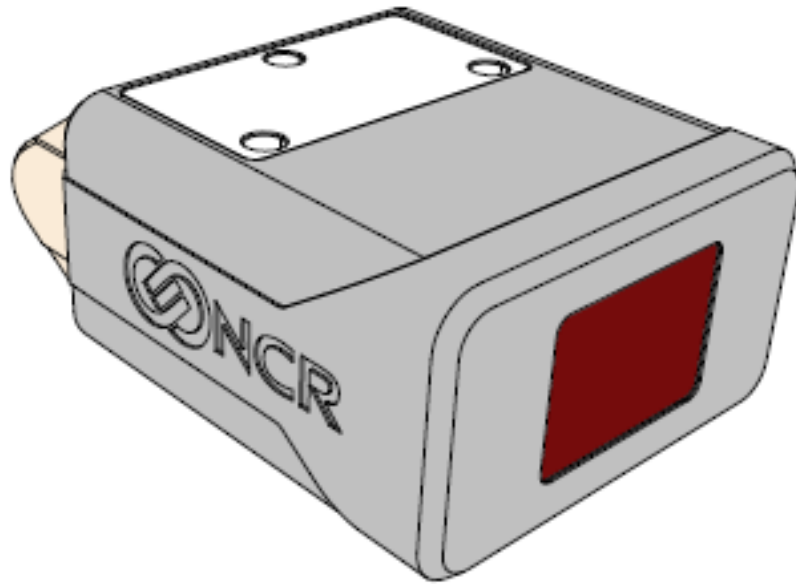

Installing the Imager Module

The RealScan Remote Image is easily connected to the existing USB ports of NCR 78xx series scanners.

The USB Ports on each respective scanner are encircled in red below:

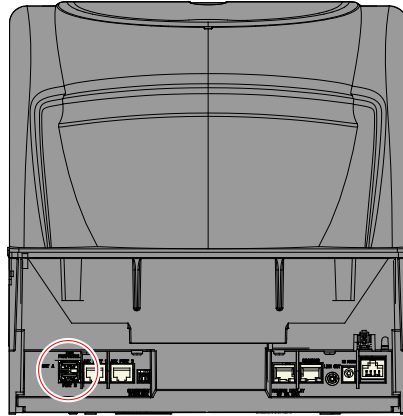

7878

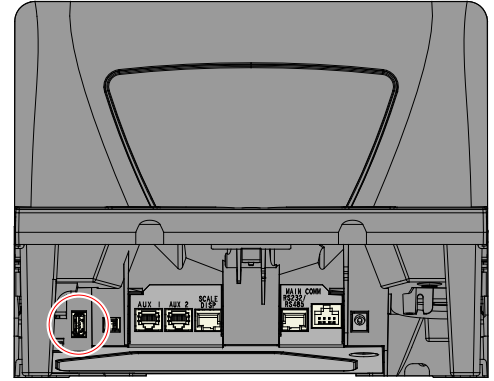

7874

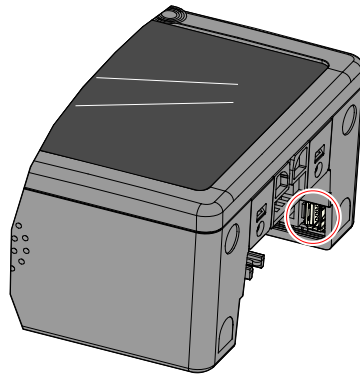

7884

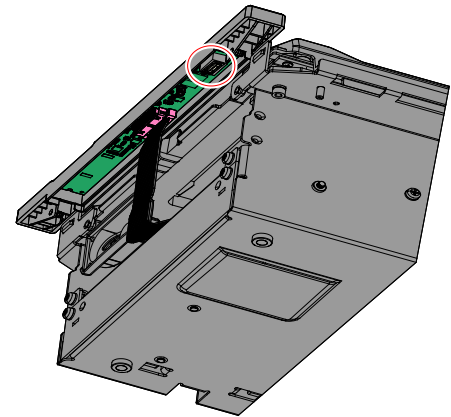

7812

Programming Instructions

Program the Host Scanner for the Remote Imager

The host scanner (7878, 7874, 7884, or 7812) must be programmed so that it can perform the following:

- Permit 2D data to pass through the POS
- Enable the K350 mode

I M P O R T A N T

The following programming instructions are ONLY meant to enable the newly installed RealScan remote imager module.

They are NOT intended to be a substitute for the customer's already-programmed parameters.

Do NOT scan the DEFAULT barcode at any time when installing the Remote Imager Module or the Customer's original parameters will be lost and their scanners will stop working.

To program the host scanner, scan the following bar codes:

Reset



Programming Mode



R0042

Enable 2D Pass-Through Function for all 2D Types

Note: The passed-through PDF data is transmitted in ASCII when RS-232 Serial or NCR USB is used. This data format is required by NCR OPOS for 2D bar codes.

Hex 7

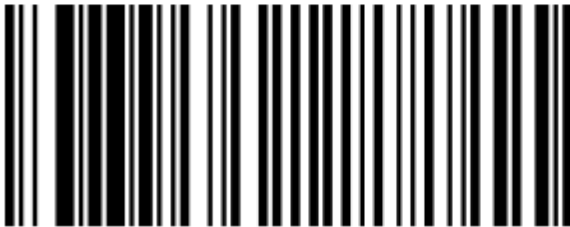

R0055

Hex F

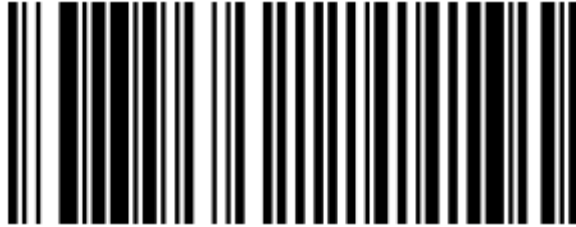

R0063

Hex 9

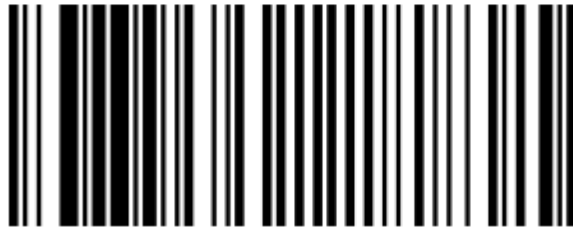

R0057

Activate Beep Sounds on the 7878 Scanner

Note: This function is optional. The imager module produces beep sounds on its own.

Hex 4

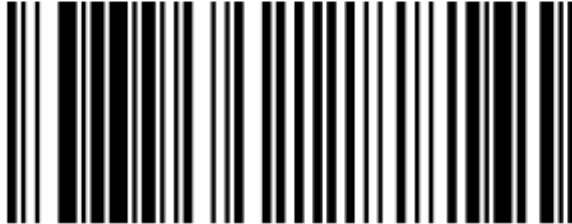

R0052

Hex 0



R0048

Hex 5



R0053

Enable the Imager Module on the 7884, 7874, and 7812

Caution: Do not perform this sequence on the 7878. If a K150 has already been installed, performing this on a 7878 turns-off the embedded imager.

Hex 8

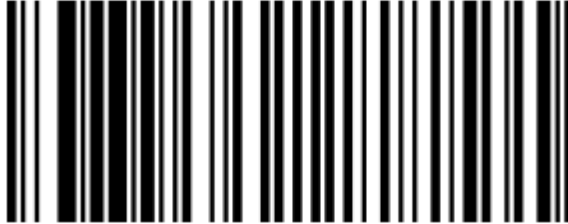

R0056

Hex B

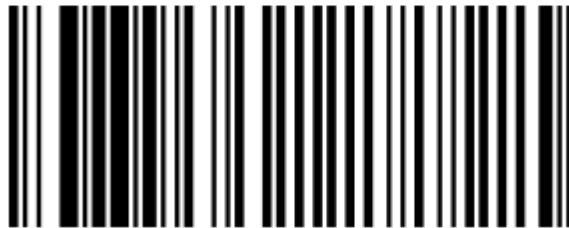

R0059

Hex 0

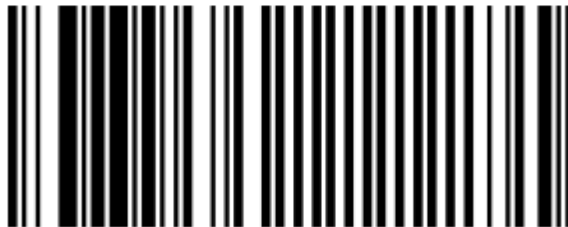

R0048

Save and Reset

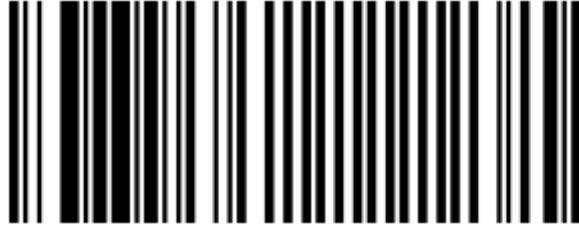

R0044

Program the Imager Module

The RealScan Remote Imager provides a limited number of symbologies enabled at the factory, including the following:

- **UPC-A**
- **UPC-E**
- **EAN-8**
- **EAN-13**
- **PDF417**
- **GS1 Databar 14 (RSS-14)**
- **GS1 Databar Expanded (RSS-14 Expanded)**
- **GS1 Databar Coupons**

To enable other symbologies not listed above, scan the corresponding bar codes in the following pages. It is also possible to enable all the bar codes the imager reads, or selectively enable bar code one at a time.

Some linear barcodes are read by the 7878 itself without help from the imager module. Enabling these symbologies on the imager, but NOT on the 7878 causes the 7878 to produce an error tone when it receives the data from the imager.

Such linear symbologies must be enabled on both scanners.

Enable Other Individual Bar Code Symbologies

Take note of the following reminders while scanning the bar codes.

- Print and fold these pages in such a way that only one bar code shows per page.
- Carefully scan the bar codes to the window so that the imager can see and read them.
- Scan only the bar codes needed for the store. The Remote Imager beeps once a bar code is read.
- No Program Mode or Save and Reset bar codes are needed.
- To know if the symbologies are successfully read, scan the sample bar codes found in the “Sample 2D Bar Codes” section.

Enable DataMatrix

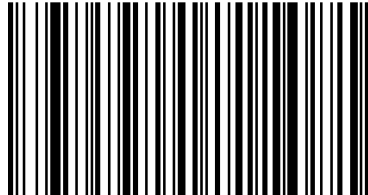

Enable Aztec

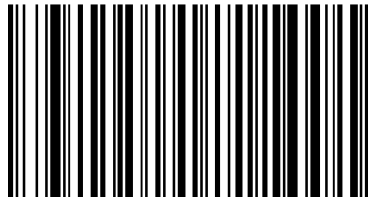

Enable QR Code

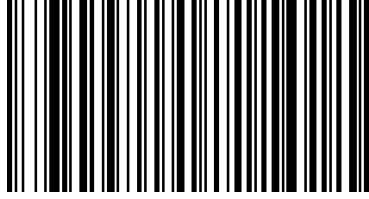

Note: This bar code also enables MicroQR.

Enable MaxiCode

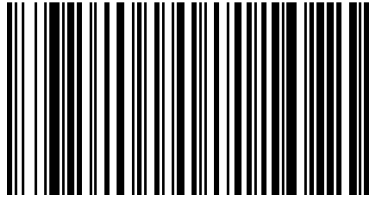

Enable Code 93

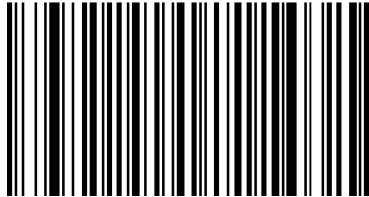

Note: Ensure that the following four symbologies are also enabled on the 78xx scanner.

Enable Code 128

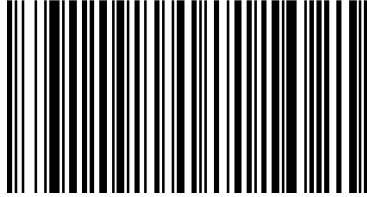

Enable UCC/EAN-128

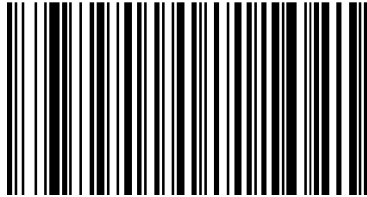

Enable Code 39

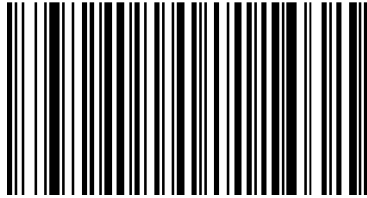

Enable ITF

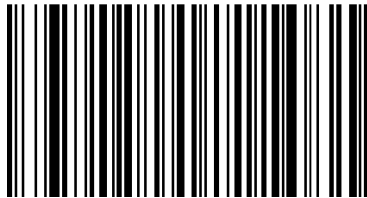

Sample 2D Bar Codes

Sample Aztec



Sample DataMatrix



Sample QR Code



Sample MaxiCode

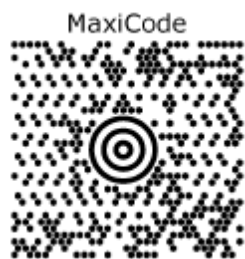

Sample PDF417

Customer 3



Reset the Imager to Default

The RealScan Remote Imager should be preset with the default NCR settings. The following bar code sets the imager to the necessary default configuration in order to work with an NCR USB. The bar code also resets the imager to the factory default symbologies, without affecting the basic communication to the NCR scanner.

Scan the bar code only when there is a need to reset to the default symbologies, as listed on page 9.

